







# Rollo-Systeme



# Übersicht

| Bedienungsart   | Abmessungen |       |       |                     |         | Anwendungen | Profil        |              | Eigenschaften / Optionen |                |             |                    |                        |                       |                   | Montage / Optionen       |               | Montage / Oberflächen |                     |      | Systeme |       |                  |
|---|-------------|-------|-------|---------------------|---------|-------------|---------------|--------------|--------------------------|----------------|-------------|--------------------|------------------------|-----------------------|-------------------|--------------------------|---------------|-----------------------|---------------------|------|---------|-------|------------------|
|   | min.        | max.  | max.  | m <sup>2</sup> max. | kg max. |             | Extrem schwer | Profilnummer | Profildurchmesser (ø mm) | Doppelfunktion | Design Case | Gekoppeltes System | Seite an Seite Montage | Seitliche Verspannung | Abdeckblende 4702 | Stop Kontrolle anwendbar | Deckenmontage | Wandmontage           | Fensterahmenmontage | Holz |         | Beton | Abgehängte Decke |
|    | 50 cm       | 2 m   | 3 m   | 6 m <sup>2</sup>    | 2 kg    |             | 4227          | ø 32         | ●                        |                | ●           |                    |                        |                       | ●                 | ●                        | ●             | ●                     | ●                   | ●    | ●       | ●     | 4800             |
|    | 50 cm       | 2 m   | 3 m   | 6 m <sup>2</sup>    | 2 kg    |             | 4227          | ø 32         | ●                        | ●              | ●           |                    |                        | ●                     | ●                 | ●                        | ●             | ●                     | ●                   | ●    | ●       | ●     | 4810 DF          |
|  | 50 cm       | 2 m   | 2.8 m | 6 m <sup>2</sup>    | 2 kg    |             | 4141          |              |                          | ●              | ●           |                    |                        | ●                     | ●                 | ●                        | ●             | ●                     | ●                   | ●    | ●       | ●     | 4140 Design Case |
|  | 45 cm       | 2 m   | 3 m   | 6 m <sup>2</sup>    | 3.5 kg  |             | 4801          | ø 32         | ●                        |                | ●           |                    |                        |                       | ●                 | ●                        | ●             | ●                     | ●                   | ●    | ●       | ●     | 4810             |
|  | 45 cm       | 2.3 m | 3 m   | 6 m <sup>2</sup>    | 3.5 kg  |             | 4544          | ø 40         | ●                        |                | ●           |                    |                        |                       | ●                 | ●                        | ●             | ●                     | ●                   | ●    | ●       | ●     | 4820             |
|  | 50 cm       | 3.3 m | 4 m   | 10 m <sup>2</sup>   | 7 kg    | ●           | 4701          | ø 55         |                          |                | ●           | ●                  | ●                      | ●                     | ●                 | ●                        | ●             | ●                     | ●                   | ●    | ●       | ●     | 4830             |
|  | 50 cm       | 4 m   | 6 m   | 15 m <sup>2</sup>   | 9.5 kg  |             | 4901          | ø 80         |                          |                |             |                    |                        |                       | ●                 | ●                        | ●             | ●                     | ●                   | ●    | ●       | ●     | 4840             |
|   | 50 cm       | 5 m   | 6 m   | 15 m <sup>2</sup>   | 9.5 kg  | ●           | 4957          | ø 110        |                          |                |             |                    | ●                      | ●                     | ●                 | ●                        | ●             | ●                     | ●                   | ●    | ●       | ●     |                  |

| Bedienungsart | Abmessungen |       |       |                        |            | Anwendungen | Profil | Eigenschaften / Optionen |              |                          |                |             |                    | Montage / Optionen | Montage / Oberflächen | Systeme |                        |                       |                   |                          |               |             |
|---------------|-------------|-------|-------|------------------------|------------|-------------|--------|--------------------------|--------------|--------------------------|----------------|-------------|--------------------|--------------------|-----------------------|---------|------------------------|-----------------------|-------------------|--------------------------|---------------|-------------|
|               | min.        | max.  | max.  | m <sup>2</sup><br>max. | kg<br>max. |             |        | Extrem schwer            | Profilnummer | Profildurchmesser (ø mm) | Doppelfunktion | Design Case | Gekoppeltes System |                    |                       |         | Seite an Seite Montage | Seitliche Verspannung | Abdeckblende 4702 | Stop Kontrolle anwendbar | Deckenmontage | Wandmontage |
| 24 V          | 35 cm       | 2 m   | 3 m   | 6 m <sup>2</sup>       | 3.5 kg     |             | 4227   | ø 32                     | ●            |                          |                |             |                    |                    |                       | ●       | ●                      | ●                     | ●                 | ●                        | ●             | 4850        |
| 230 V         | 55 cm       | 2.2 m | 3.5 m | 7.5 m <sup>2</sup>     | 7.5 kg     |             | 4544   | ø 40                     | ●            | ●                        |                |             |                    |                    |                       | ●       | ●                      | ●                     | ●                 | ●                        | ●             | 4860        |
| 230 V         | 70 cm       | 3.3 m | 5 m   | 14 m <sup>2</sup>      | 10 kg      |             | 4701   | ø 55                     |              | ●                        |                | ●           | ●                  |                    |                       | ●       | ●                      |                       | ●                 | ●                        | ●             | 4870        |
| 230 V         | 72 cm       | 4 m   | 12 m  | 36 m <sup>2</sup>      | 23 kg      | ●           | 4901   | ø 80                     |              |                          |                |             |                    |                    |                       | ●       | ●                      |                       | ●                 | ●                        | ●             | 4880        |
|               | 72 cm       | 5 m   | 9 m   | 36 m <sup>2</sup>      | 23 kg      |             | 4957   | ø 110                    |              |                          |                |             | ●                  |                    |                       |         | ●                      | ●                     |                   | ●                        | ●             |             |

### Design Case und Abdeckblende

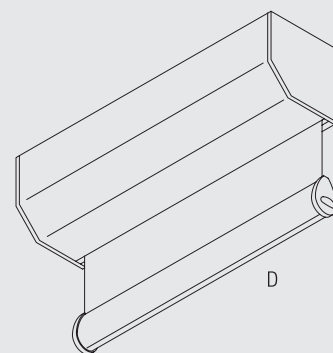
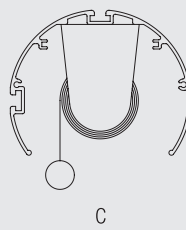
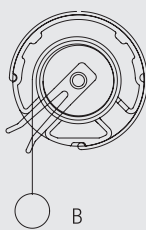
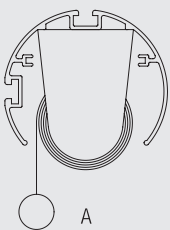

A: Design Case 4120 kann mit folgenden Systemen eingesetzt werden:  
4800 / 4810 / 4810DF / 4850

B: Design Case 4140 kann mit folgenden Systemen eingesetzt werden:  
4800 / 4810DF / 4850

C: Design Case 4130 kann mit folgenden Systemen eingesetzt werden:  
4800 / 4810 / 4810DF / 4820 / 4850 / 4860

D: Abdeckblende 4702 kann mit folgenden Systemen eingesetzt werden:  
4830 / 4870

Anwendung abhängig von der Stoffqualität.









[www.silentgliss.de](http://www.silentgliss.de)

Silent Gliss GmbH  
Rebgartenweg 5  
D - 79576 Weil am Rhein  
  
Tel. +49 (0) 7621 6607 0  
Fax +49 (0) 7621 6607 37  
info@silentgliss.de

[www.silentgliss.at](http://www.silentgliss.at)

Silent Gliss GsmbH  
Gewerbestrasse 6  
A - 6710 Nenzing  
  
Tel. +43 (0) 5525 64 111  
Fax +43 (0) 5525 63 170  
  
Vertriebsbüro / Showroom  
Stubenring 6  
A - 1010 Wien  
Tel. +43 (0) 1 513 16 77  
Fax +43 (0) 1 513 16 77-88  
info@silentgliss.at